



# Intelligent Refractor RT-3100



THE ART OF EYE CARE



# Reliability and Technology

**Sophisticated design and comfortable examination at the same time**

The RT-3100 empowers you to perform operations seamlessly and accurately. The Eye Care card system, printer and quick software upgrades strongly support the examination process. In addition to these functions, connection to EMR (Electric Medical Record) and comparison between auto refractometer and lensmeter data can be performed with the single touch of a button.



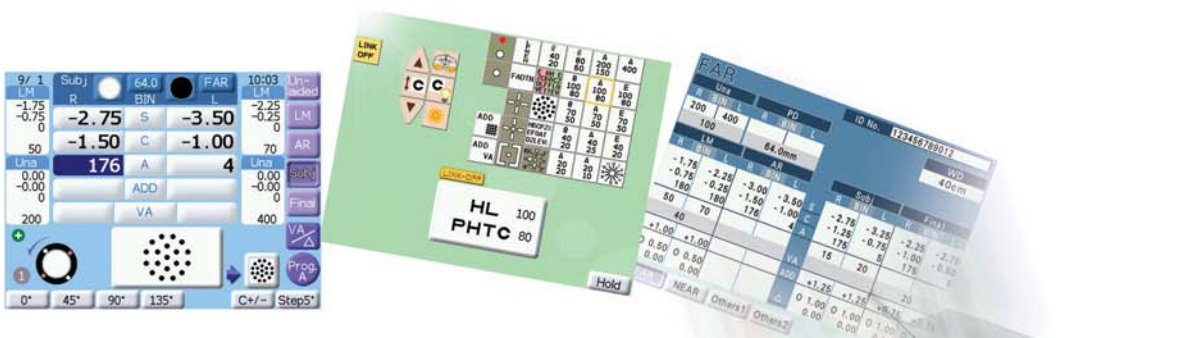

## Operator-oriented Control Box

### ■ Intuitive color LCD touch screen

The 5.7-inch color LCD touch screen displays all data with high visibility. Simple, understandable, and comfortable user interfaces ensure an effective operation.

### ■ Easy on-off LED lamp

LED lamp for VA chart and near point chart can be easily turned on/off, by touching the icon on screen.

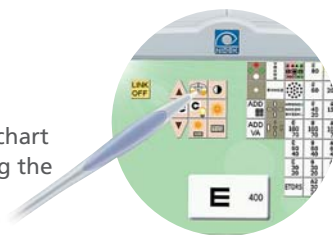

### ■ Jog dial with S/C/A mode key

The jog dial on the control box provides smooth operation. The S/C/A mode key on the center of dial allows the operator to quickly change sphere, cylinder and axis powers using only one hand.



### ■ Cross cylinder test

Cross cylinder test is effective for determining the astigmatism correction. Axis adjustment is accomplished with the touch of a button. Spherical power is adjusted automatically to maintain spherical equivalent.



## Built-in High Speed Line Printer

The RT-3100's control box includes a built-in, high-speed printer. It automatically prints out the measured results, and the data is simply laid out so that operator can easily explain to patients. Replacing the paper is totally effortless and takes only a few seconds.



<pre> ID : 123456789012 NAME / 3/2008 10:13:44 AGE : 40.00 SEX : M REFR : 1.75 SPH - 2.25           -0.75 CYL -0.25           +1.00 ADD +1.00           VA           ( 60 ) ( 60 ) 80 0.50 PRISM 80 0.50 B 0.00 POL(L) 80.0 ---(R)---(L)---(R)---(L)--- FAK -3.00 SPH - 3.50 -1.50 CYL -1.00 175° ASE 5° ---(R)---(L)---(R)---(L)--- FAK -2.75 SPH - 3.25 -1.25 CYL -0.75 175° ASE 5° +2.00 ADD +2.00 VA ( 15 ) ( 20 ) B 0.00 PRISM 80 2.00 B 0.00 POL(R) 80.0 -2.75 SPH - 3.25 -1.25 CYL -0.75 175° ASE 5°           </pre>	<pre> ---(R)---(L)---(R)---(L)--- FAK -2.25 SPH - 2.75 -1.00 CYL -0.50 +1.50 ADD +1.50 VA ( 20 ) 80 1.00 PRISM 80 1.00 B 0.00 POL(L) 80.0 -0.75 SPH - 1.25 -1.00 CYL -0.50 175° ASE 5° ---(R)---(L)---(R)---(L)--- FAK -2.25 SPH - 2.75 -1.00 CYL -0.50 175° ASE 5° +1.50 ADD +1.50 VA ( 20 ) 80 1.00 PRISM 80 1.00 B 0.00 POL(R) 80.0 -2.25 SPH - 2.75 -1.00 CYL -0.50 175° ASE 5°           </pre>
--	--

## Easy Software Upgrades

Quick and easy future upgrades can be performed with CompactFlash\* card.

\*CompactFlash is a trade mark of SanDisk Corporation.

Printout examples

## Ergonomically-designed Refractor Head

### ■ Comfortable examination

The RT-3100 has a sophisticated, ergonomic design. Furthermore, visual field of 40 degrees provides a spacially open and comfortable examination for patients.

### ■ Smooth, quick, silent lens selection

The control box makes it smoother, quicker, and more accurate to refine sphere, cylinder, axis, and prism lenses compared to examinations with the manual refractor.

With the press of a button, internal lenses can be changed quickly, so that the patient can actually see and compare their vision with the new correction to either unaided, or their current glasses prescription\*.

\*It requires data transfer from a NIDEK auto lensmeter or manual entry.

Please contact us for further information.

#### Current Vision



#### Corrected Vision



Patient's vision can be compared instantly!



### ■ Power convergence and power PD

During near point tests, power convergence and power PD are adjusted automatically.

### ■ R/L independent PD adjustment for improved precision

Right and left PD can be adjusted independently for more accurate and reliable measurements, preventing axis shift.

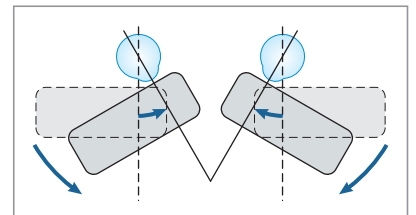

### ■ Clear, white LED illumination

Bright and energy efficient white LED illuminates the near chart for near point examination.



### ■ Easy maintenance

Effortless maintenance is made possible by antifogging protective glasses, and detachable forehead rest / face shields.

### ■ High quality near point card

Washable, plastic near point card is attached to the RT-3100's main body.

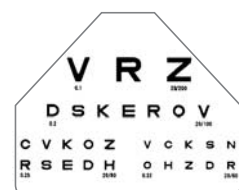

Working Distance: 40 cm (16 inch)



## Quick and Easy Wireless Data Transfer

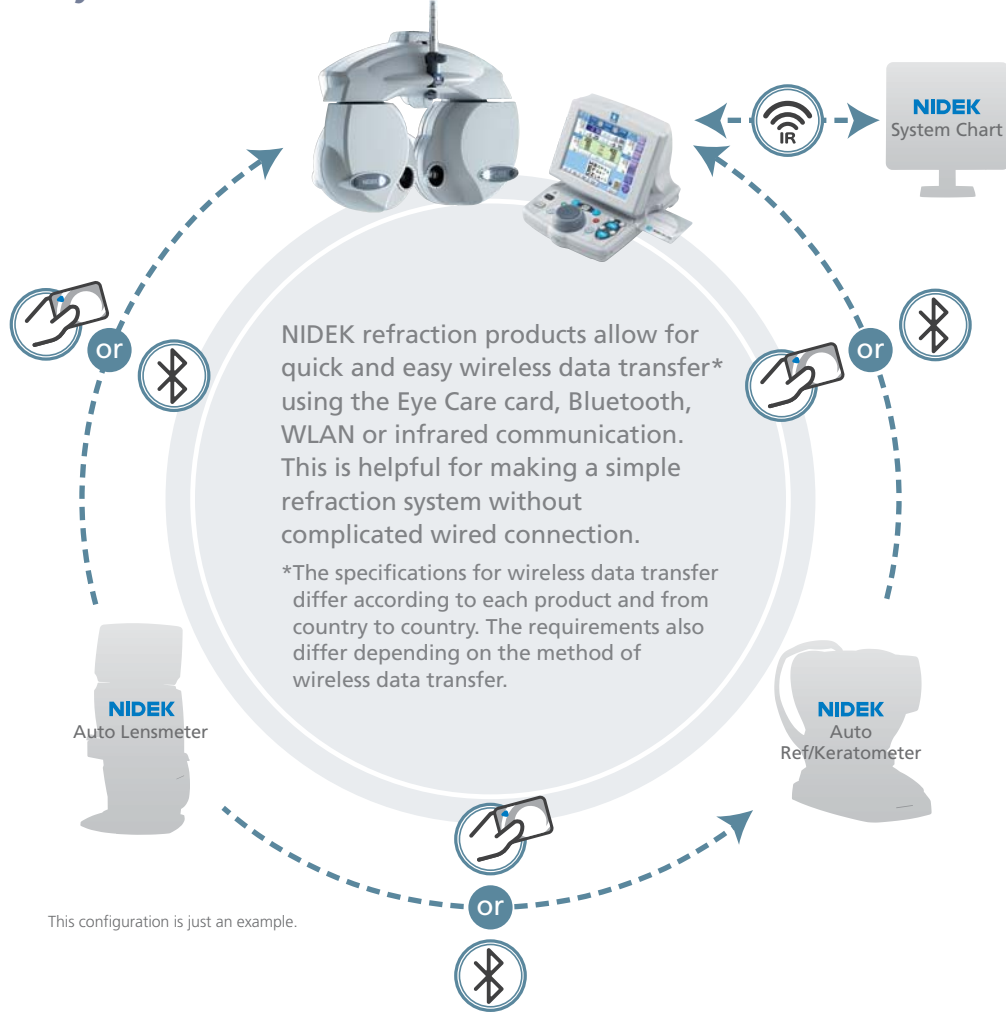

### Dimensions (mm)

#### Refractor Head (Main Body: MB)

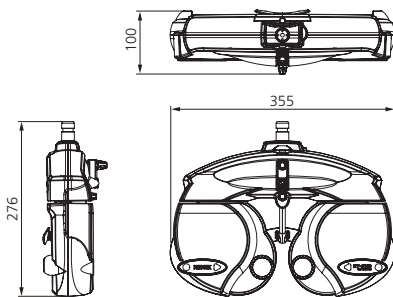

#### Control Box (CB)

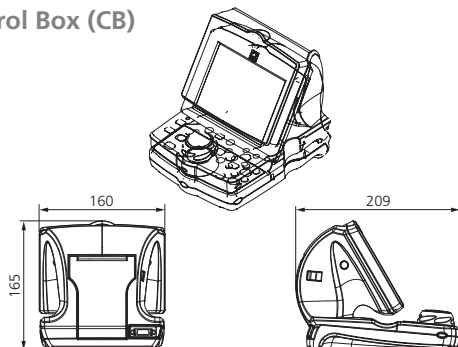

### System Configuration

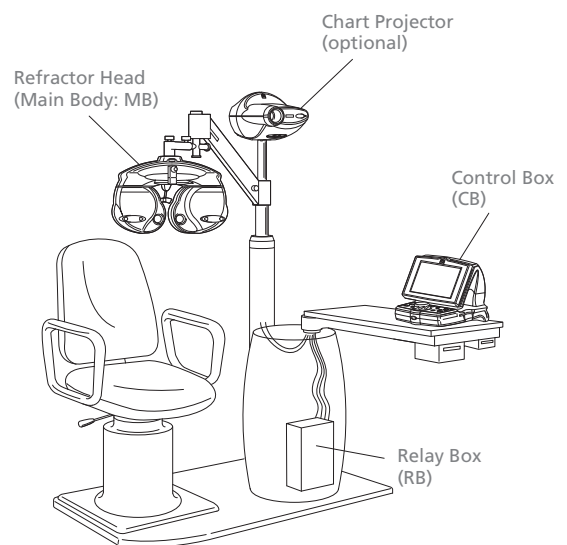

\*This configuration is just an example.  
Please contact us for further information.

## RT-3100 Specifications

Measurable range	
Sphere	-19.00 to +16.75 D (0.25/0.5 to 3.0 D increments)
Cylinder	0.00 to $\pm 6.00$ D (0.25/1 D increments)
Axis	0 to 180° (1°/5° increments)
PD	48 to 80 mm (far mode) 50 to 74 mm (near working distance of 35 cm) 54 to 80 mm (far PD possible for 100% convergence)
Prism	0 to 20 $\Delta$ (0.1/0.5/2 $\Delta$ increments)
Auxiliary lens	
Cross cylinder lens	$\pm 0.25$ D
Occluder	Available
Pinhole plate	$\phi 2$ mm
Red/Green filter	Right eye: red, Left eye: green
Polarizing filters	Right eye: 135° / Left eye: 45° , Right eye: 45° / Left eye: 135°
Fixed cross cylinder lens	$\pm 0.50$ D
Spherical lenses for retinoscope	+1.5/+2.0 D
Red maddox rod	Right eye: horizontal, Left eye: vertical
Dissociation prism	Right eye: 6 $\Delta$ BU / Left eye: 10 $\Delta$ BI, Right eye: 3 $\Delta$ BD / Left eye: 3 $\Delta$ BU
Visual field	40° (VD = 12 mm), 39° (VD = 13.75 mm)
Refraction distance for near vision	350 to 700 mm (50 mm increments)
Forehead rest adjustment	14 $\pm$ 2 mm
Vertex distance marking	12, 13.75, 16, 18, 20 mm
Level adjustment	$\pm 2.5^\circ$
Display	5.7-inch color
Printer	High speed line printer
Interface	RS-232C
Power supply	AC 100 to 240 V, 50/60 Hz
Power consumption	80 VA
Dimensions/Mass	
Refractor head	355 (W) x 100 (D) x 276 (H) mm / 3.5 kg 14.0 (W) x 3.9 (D) x 10.9 (H)" / 7.7 lbs.
Control box	160 (W) x 209 (D) x 165 (H) mm / 1.7 kg 6.3 (W) x 8.2 (D) x 6.5 (H)" / 3.7 lbs.
Relay box	194 (W) x 227 (D) x 61 (H) mm / 2.0 kg 7.6 (W) x 8.9 (D) x 2.4 (H)" / 4.4 lbs.
Standard accessories	Near point card, Near point rod, Forehead rest, Face shield, Stylus pen, Dust cover, Communication cable, Printer paper, Power cord, Hexagonal wrench
Optional accessories	Eye Care card (IC card), EyeCa-RW2, Memory Box

All LCD images are simulated.

Product/Model name: Refractor RT-3100

Brochure and listed features of the device are intended for non-US practitioners.

Specifications may vary depending on circumstances in each country.

Specifications and design are subject to change without notice.



**HEAD OFFICE**  
(International Div.)  
34-14 Maehama, Hiroishi  
Gamagori, Aichi 443-0038,  
JAPAN  
TEL: +81-533-67-8895  
URL: <http://www.nidek.com>  
[Manufacturer]

**TOKYO OFFICE**  
(International Div.)  
3F Sumitomo Fudosan Hongo  
Bldg., 3-22-5 Hongo, Bunkyo-ku,  
Tokyo 113-0033, JAPAN  
TEL: +81-3-5844-2641  
URL: <http://www.nidek.com>

**NIDEK INC.**  
47651 Westinghouse Drive,  
Fremont, CA 94539, U.S.A.  
TEL: +1-510-226-5700  
+1-800-223-9044  
(US only)  
URL: <http://usa.nidek.com>

**NIDEK S.A.**  
Europarc,  
13 rue Auguste Perret,  
94042 Créteil, FRANCE  
TEL: +33-1-49 80 97 97  
URL: <http://www.nidek.fr>

**NIDEK TECHNOLOGIES S.R.L.**  
Via dell'Artigianato,  
6/A, 35020 Albignasego (Padova),  
ITALY  
TEL: +39 049 8629200/8626399  
URL: <http://www.nidektechnologies.it>

**NIDEK (SHANGHAI) CO., LTD.**  
Rm3205, Shanghai Multi  
Media Park, No.1027 Chang  
Ning Rd, Chang Ning District,  
Shanghai, CHINA 200050,  
TEL: +86 021-5212-7942  
URL: <http://www.nidek-china.cn>

**NIDEK SINGAPORE PTE. LTD.**  
51 Changi Business Park  
Central 2, #06-14, The  
Signature 486066,  
SINGAPORE  
TEL: +65 6588 0389